

Features

- * 7 digit LCD display
- * Hour:Minute Second display
- * Month Date weekday display
- * Alarm with Chime
- * 32 World time display.
- * DST function
- * 2/3 keys operation
- * 12/24Hour display
- * 1/2 bias 1/3 duty LCD format
- * Built in EL driver.
- * Very low power consumption
- * 32768 Crystal oscillator
- * Single 3.0V operation.

General Description

The LS6055 is a 7 digit LCD watch I.C. with Hour:Minute Second, Month Date weekday display. It support 12H/24 H display format and has a time alarm and hourly chime function. It has built-in world time display of 32 major city. DST function for all cities can be enable/disabled individually. It can support 2/3 keys operation : KM, KS, KR. It has built-in EL driver controlled by KEL.

LCD Display

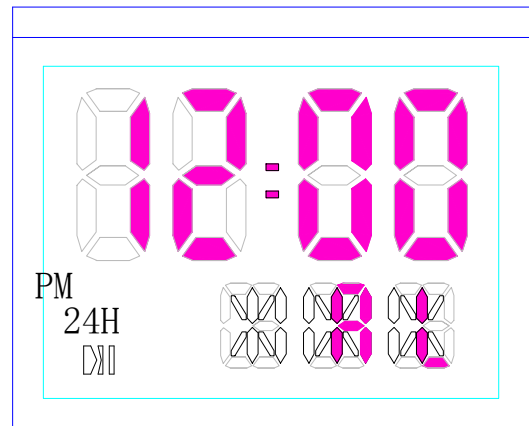
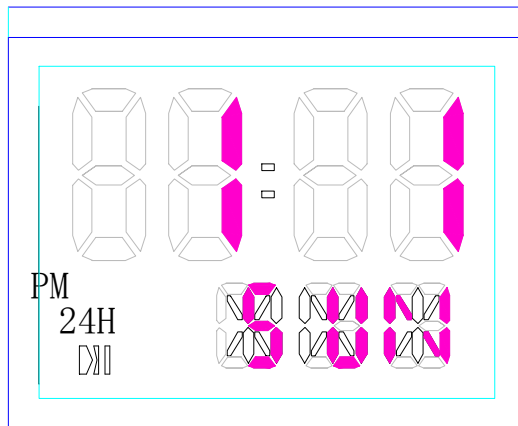

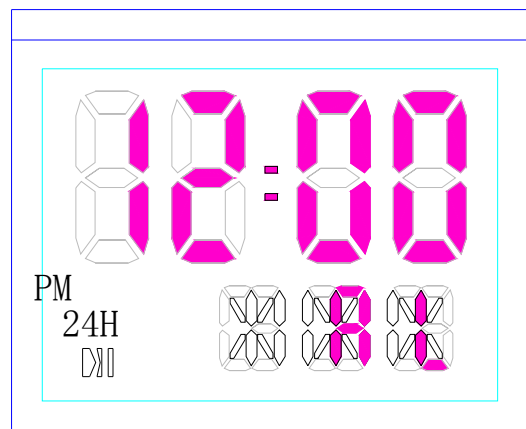
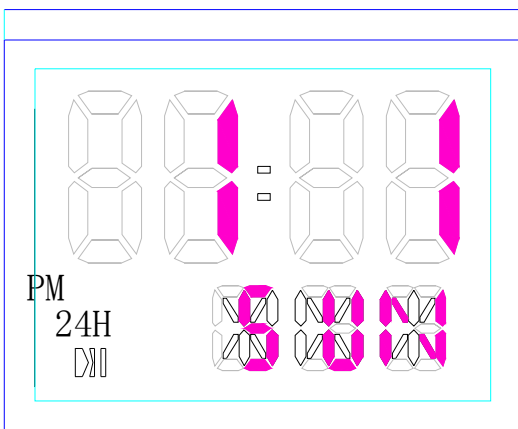
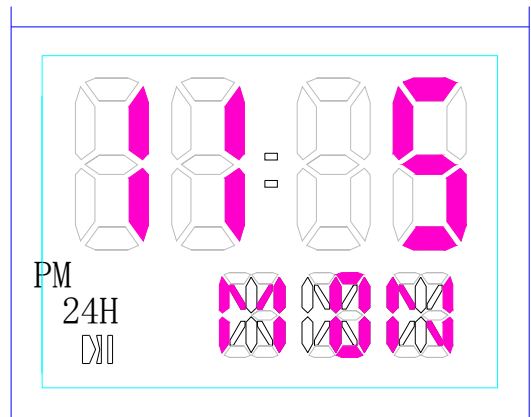
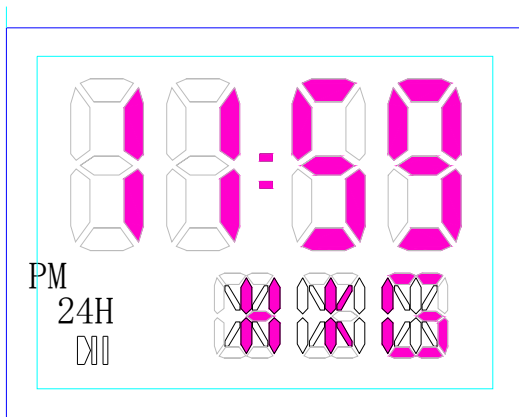
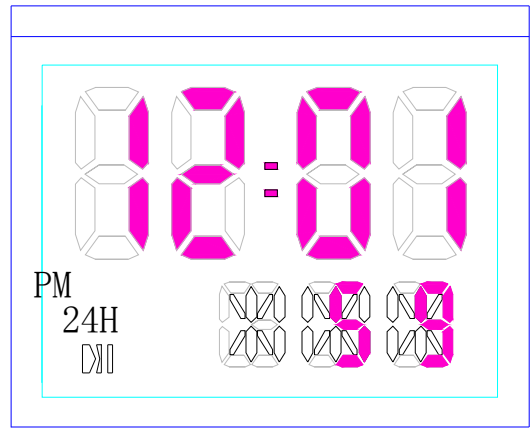
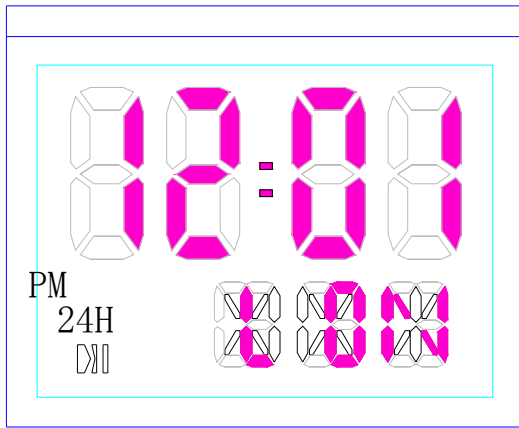

Bonding option

BOP	Description
GND	3 key operation : KM, KS, KR + KEL
VDD	2 key operation : KM, KS + KEL

Operation Modes

The LS6055 has 4 modes – Clock, Date, World time and Alarm Mode.

By pressing KM, it is shift from one mode to another as follow :

Time Mode => Date Mode => World time Mode=> Alarm Mode => Time Mode....

In Date Mode, the 6055 display current Month Date, and Weekday.

In Alarm Mode, the 6055 display the Alarm time.

Time Mode

In Time Mode , the LS6055 display the current time information, Hour, Minute, Second. It also display the ON/OFF status of Alarm and Chime and 12Hr/24Hr format.

In Time Mode, press KR to toggle between 12HR and 24Hr display format (if 3 key is used).

Set Mode

At TIME mode, press KS to enter Set mode as follow:

- TIME
- ⇒ SET ALARM/CHIME ENABLE/DISABLE
- ⇒ SET ALARM HOUR
- ⇒ SET ALARM MINUTE
- ⇒ SET WEEKDAY
- ⇒ SET MONTH
- ⇒ SET DATE
- ⇒ SET HOUR
- ⇒ SET MINUTE
- ⇒ RESET SECOND
- ⇒ TIME

- Press KM to adjust the setting value.
- In Setting Mode, press KR to exit from setting mode and go to Time Mode.
- If alarm time is adjusted, press KS will go to TIME mode after setting ALARM MINUTE.
- 12H/24H can be selected during SET HOUR
- SECOND can only be reset.

World Time Mode

In World Time Mode, if 3 key is used (BOP==GND),
 press KR to review different time zone,
 press KS to enter World Time Setting Mode .
 The setting sequence is :

World Time DST ON/OFF → World time Hour → World time Minute → World time Mode.
 (press KM to set the value).

In World Time Mode, if 2 key is used (BOP==VDD),
 press KS to review different time zone.
 Press KS over 2 second enters World Time Setting Mode .
 The setting sequence is :

World Time DST ON/OFF → World time Hour → World time Minute → World time Mode.
 (press KM to set the value).

EL Output

When KEL is pressed, R0,R1 provide the waveform to drive external EL circuit, the EL delay is around 2 – 3 second.

The R0, R1 output waveform is as follows :

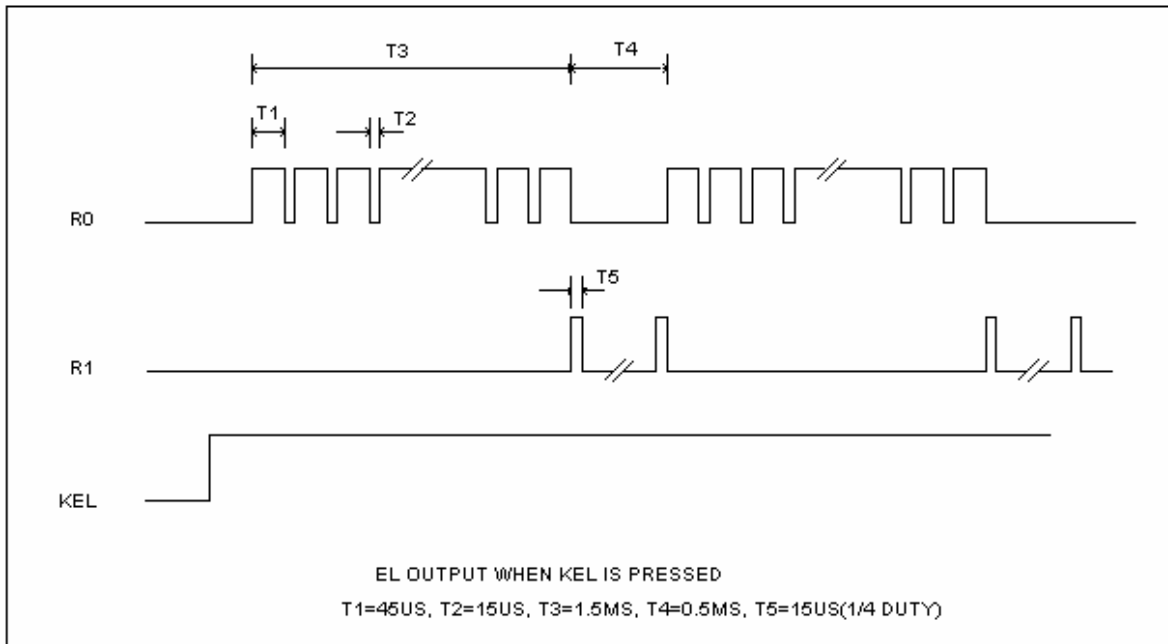

Oscillator Trim Capacitor

The 32kHz crystal is connected across pad OI and OO when external trim capacitor is used.
 The OI15PF can be used instead of OI which use internal capacitor of around 10-15pf.

ALL SEGMENT ON

When power up, the system will turns on all LCD segment for 2 – 3 seconds.

32 World Time is built-in the LS6055 as:

ZONE	RELATIVE TO GMT	
HNL	-10	Honolulu
ANC	-9	
LAX	-8	Los Angeles
DEN	-7	Denver
CHI	-6	Chicago, Mexico City
NYC	-5	New York, Toronto
CCS	-4	
RIO	-3	Rio de Janeiro
LON	0	London
PAR	+1	Paris
AMS	+1	Amsterdam
FRA	+1	Frankfurt
CAI	+2	Cairo
JRS	+2	
JED	+3	
MCW	+3	Moscow
THR	+3 1/2	
DXB	+4	
KBL	+4 1/2	Kabul
KHI	+5	Karachi
DEL	+5 1/2	New Delhi
DAC	+6	
RGN	+6 1/2	
BKK	+7	Bangkok
HKG	+8	Hong Kong
PEK	+8	Beijing
TPE	+8	Taipei
TYO	+9	Tokyo
ADL	+9 1/2	
SYD	+10	Sydney
NOU	+11	
WLG	+12	Wellington

Pin Assignment

DESIGNATION	TYPE	DESCRIPTION
B [0:1]	OUTPUT	Buzzer output
VC1, VC2	OUTPUT	Halfer output
VEE	OUTPUT	Halfer voltage
T2, T1	INPUT (PL)	TEST pin
OO	OUTPUT	oscillator output
OI	INPUT	oscillator input
VDD	POWER	+3.0V power supply
GND	POWER	Ground
I0-I5	INPUT(PL)	Input key
R[0:1]	OUTPUT	Motor Output
C[1:3]	OUTPUT	LCD Common output
S[1:28]	OUTPUT	LCD Segment output

Note: (PL) – pull low
(PH) - pull high

Absolute Maximum Ratings

Supply voltage Vdd - Vss.....0 to 5V
 Input voltage Vin.....Vss to Vdd
 Operating temperature Top-10°C to 60°C
 Storing temperature Tst-40°C to 70°C

Comments

Stress above those listed under “Absolute Maximum Ratings” may cause permanent damage to the device. These are stress rating only. Functional operation of this device at these or any other conditions above those indicated in the operational sections of this specification is not implied and exposure to absolute maximum rating conditions for extended periods may affect device reliability.

D.C. Electrical Characteristics

(GND = 0V, Vdd = 3.0V, Ta = 25°C unless otherwise specified)

Parameter	Symbol	Min.	Typ.	Max.	Unit	Conditions
Supply Voltage	Vdd	2.5	3.0	3.6	V	
Operating current	Idd	-	3	6	μA	No load
OSC. built-in cap	Cd	-	15	-	pF	Bonding option
Buzzer output current	Ib	500	-	-	μA	Vbd-Vss=0.5
LCD frequency	Flcd	-	64	-	Hz	
Segment current	Is	0.15	-	-	μA	Vseg=0.2V
Common current	Ic	3.0	-	-	μA	Vcom=0.2V
R[0:1] output current	Ir	0.8	-	-	mA	Vr-Vss=0.7

Pad Coordinate

PAD	X(μ m)	Y(μ m)	PAD	X(μ m)	Y(μ m)
C1	-1408.20	506.10	S26	942.20	-1513.90
S16	-1408.20	372.10	S27	1076.20	-1513.90
S15	-1408.20	238.10	S28	1210.20	-1513.90
S14	-1408.20	104.10	C3	1344.20	-1513.90
S13	-1408.20	-29.90	C2	1408.00	-1287.00
S12	-1408.20	-163.90	I4/BOP	1408.00	-1151.00
S11	-1408.20	-297.90	I5	1408.00	-741.60
S10	-1408.20	-431.90	I0/KM	1408.00	-597.60
S9	-1408.20	-565.90	I1/KS	1408.00	-188.20
S8	-1408.20	-699.90	I2/KR	1408.00	-44.20
S7	-1408.20	-833.90	I3/KEL	1408.00	365.20
S6	-1408.20	-967.90	VDD	1408.00	509.20
S5	-1408.20	-1101.90	B0	1408.00	653.20
S4	-1408.20	-1235.90	T2	1408.00	797.20
S3	-1408.20	-1369.90	T1	1408.00	941.20
S2	-1408.20	-1503.90	B1	1408.00	1085.20
S1	-570.50	-1513.90	GND	1408.00	1229.20
S17	-436.50	-1513.90	OI	1400.30	1423.00
S18	-238.70	-1513.90	OI 15pF	1400.30	1513.00
S19	-104.70	-1513.90	OO	184.00	1499.30
S20	93.10	-1513.90	R0	-56.30	1499.30
S21	227.10	-1513.90	R1	-425.20	1499.30
S22	406.20	-1513.90	PB	-561.20	1499.30
S23	540.20	-1513.90	VC1	-1045.70	1499.30
S24	674.20	-1513.90	VC2	-1179.70	1499.30
S25	808.20	-1513.90	VEE	-1313.70	1499.30

Pad Location

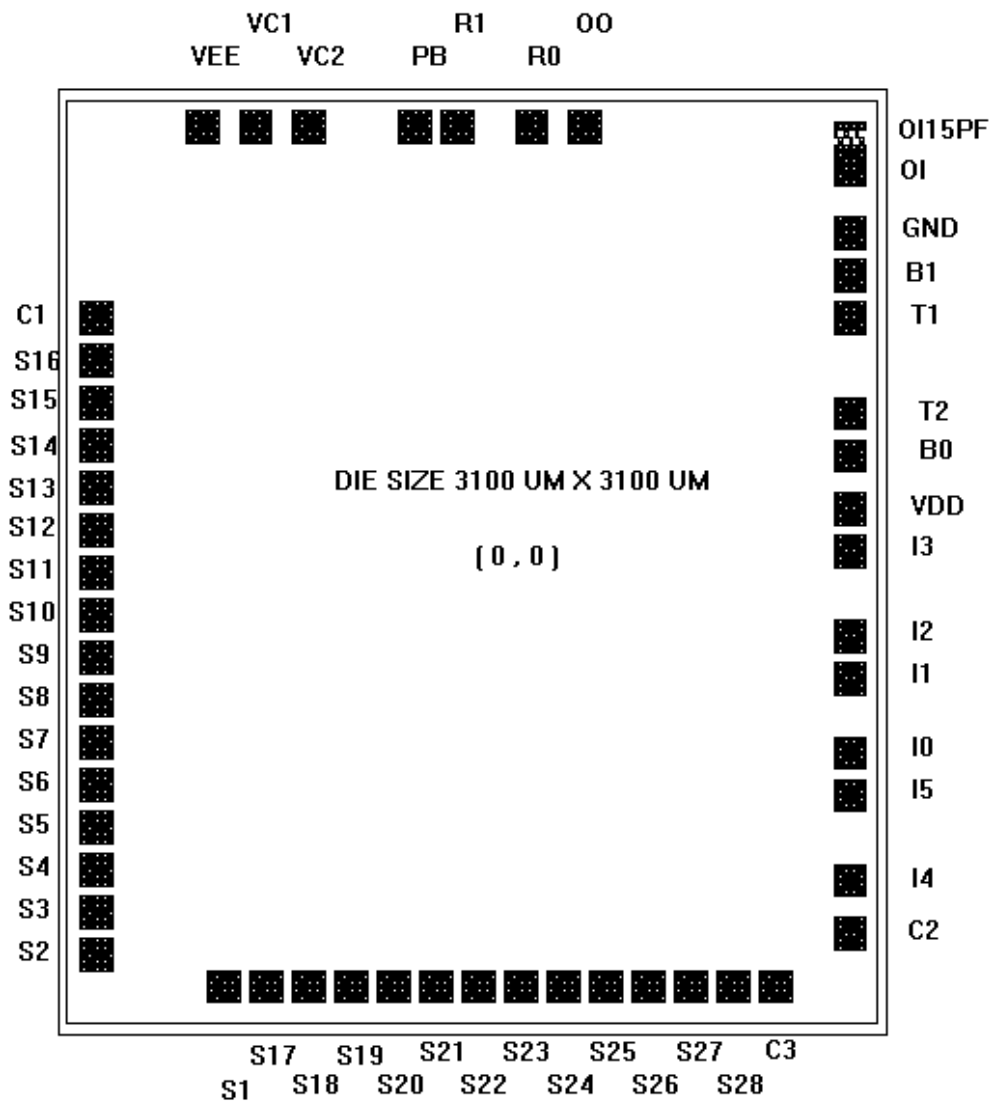

Application Circuit

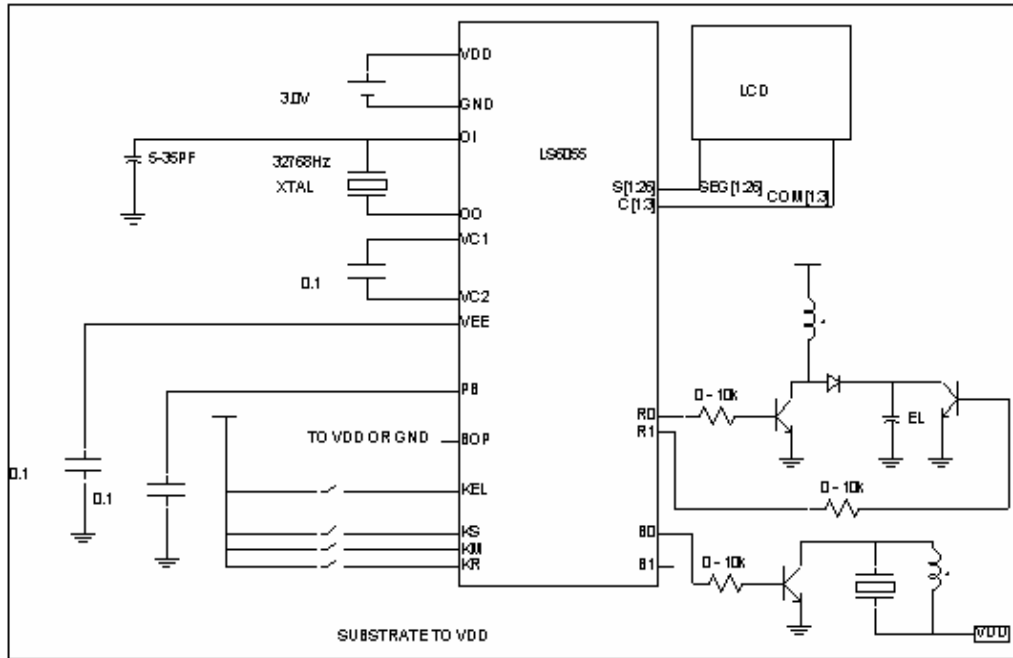

LCD Drawing

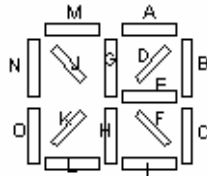
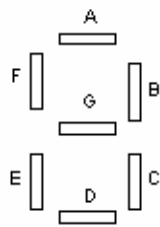
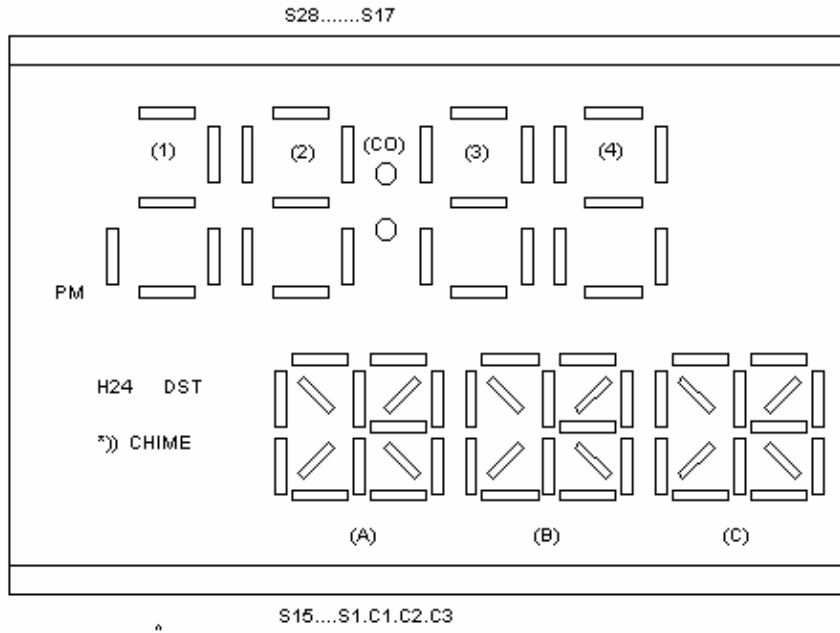

```

=====
SIG| COM1| COM2| COM3
=====
C3 |   |   | C3
C2 |   | C2 |
C1 | C1 |   |
S1 | CC | CB | CA
S2 | CF | CE | CD
S3 | CI | CH | CG
S4 | CL | CK | CJ
S5 | CO | CN | CM
S6 | BC | BB | BA
S7 | BF | BE | BD
S8 | BI | BH | BG
S9 | BL | BK | BJ
S10| BO | BN | BM
S11| AC | AB | AA
S12| AF | AE | AD
S13| AI | AH | AG
S14| AL | AK | AJ
S15| AO | AN | AM
S16|   |   |
S17| 4C | 4D | H24
S18| 4G | 4E | CHIME
S19| 4B | 4F | *) )
S20| 4A |   |
S21| 3C | 3D | DST
S22| 3G | 3E | PM
S23| 3B | 3F | CO
S24| 3A |   |
S25| 2C | 2D | 1C
S26| 2G | 2E | 1ADEG
S27| 2B | 2F | 1B
S28| 2A |   |

```

* S16 is not used
 Modification History :
 Version 0.2(15.02.01) Update LCD table, 32 Time Zone Table.